

Cuaderno
de
escritura
nº 3

Raquel Girau

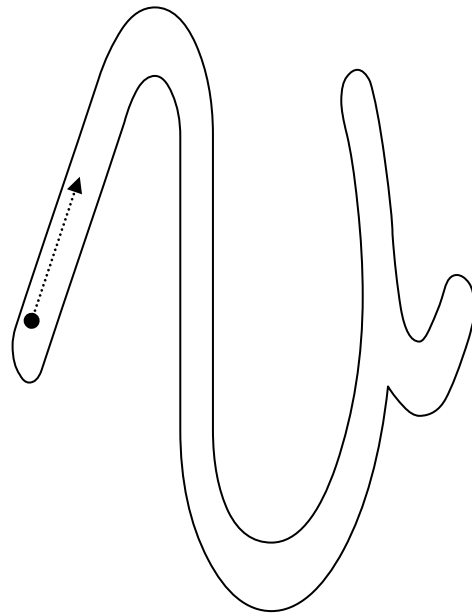

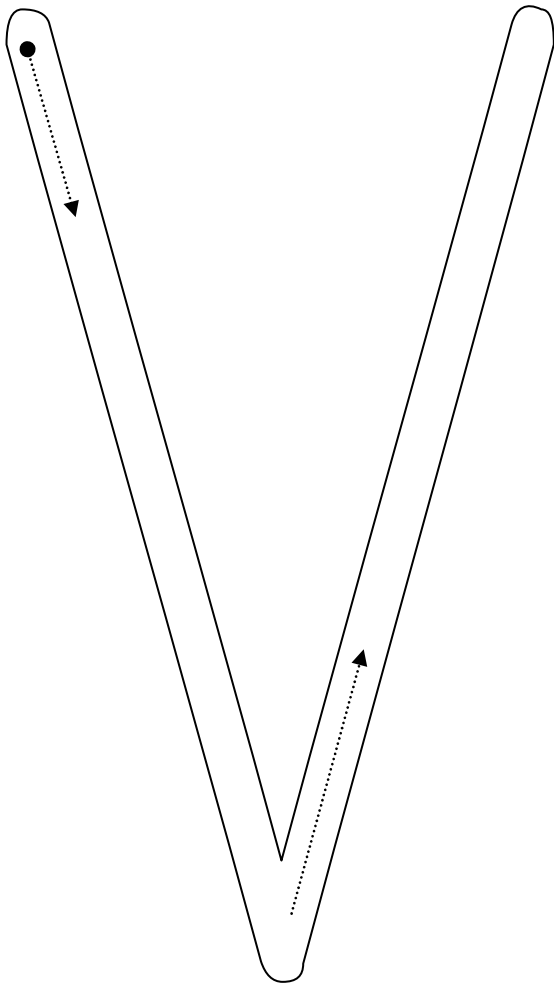
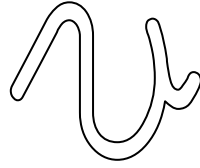
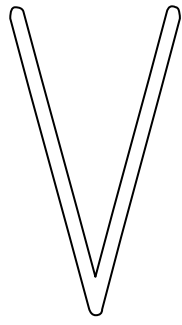

va ve vi vo vu

Ve Ve Vi Vu Va

Vaca, vaso, vela, viernes

Vino, uva, ventana, ave

Lee una novela.

Una copa de vino.

Pon la vela en el vaso.



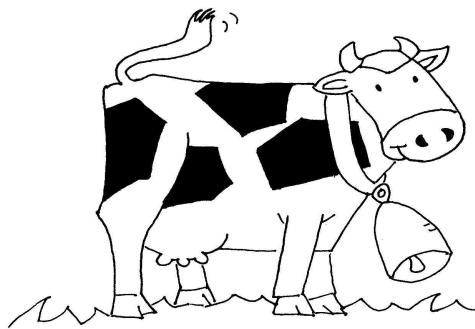

La vaca pasea por el campo.

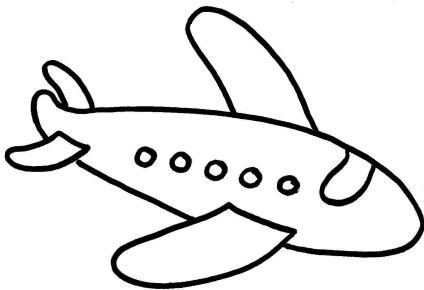

Un avión

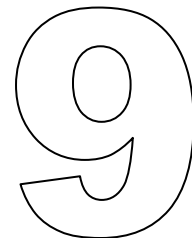

el nueve

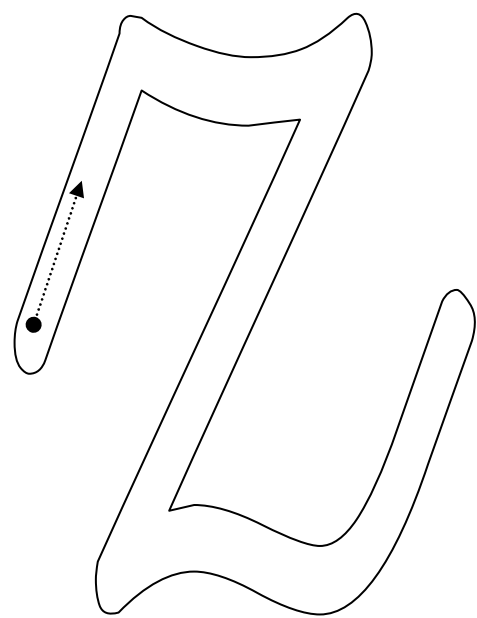
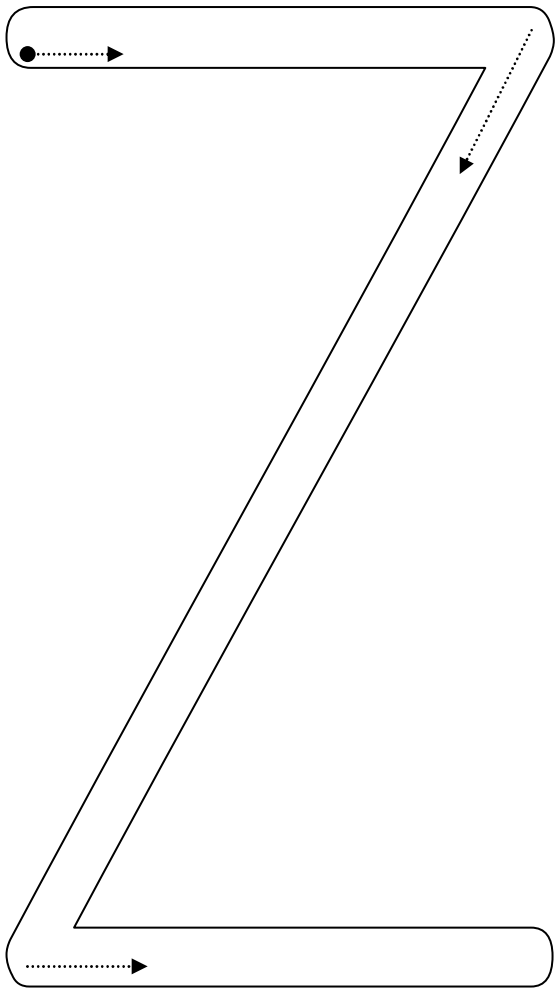

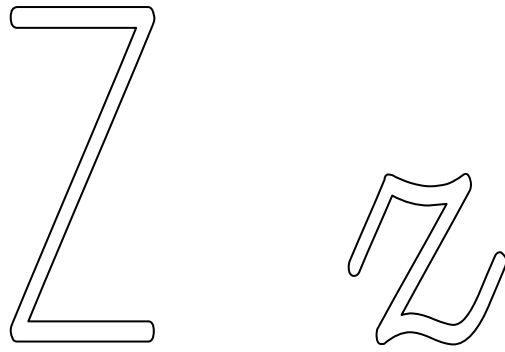

za zo zu Za Zo Zu

Zapato, zumo, azul, taza

azúcar, pozo, lazo, cazo

Pon azúcar al zumo.

Saca el cazo y las copas.

Del pozo sale agua.

10

diez

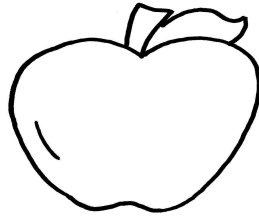

manzana

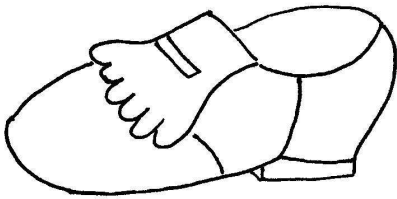

Zapato

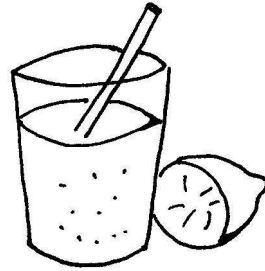

zumο

Ce ci

Cine , cielo , cinta , cesta

maceta , calcetín , cocina

cinco , cien , cemento

En la cesta hay manzanas.

El cielo está azul.

La cocina de la casa.

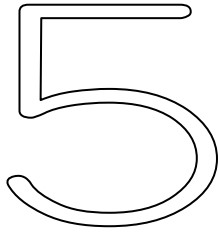

cinco

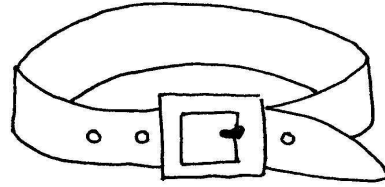

cinturón

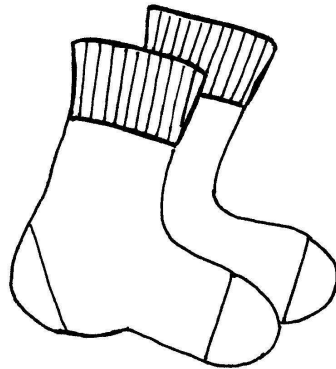

Calcetines

DICTADO

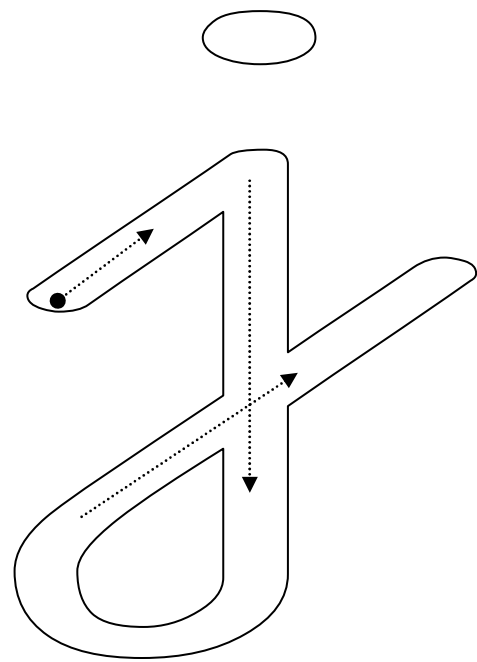
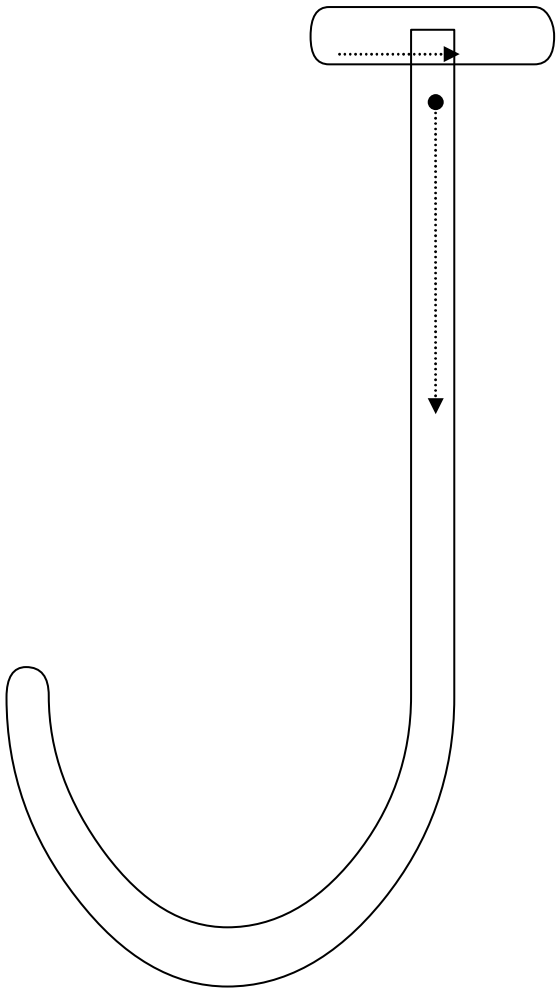

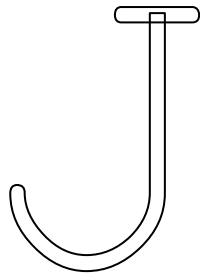

ja

je

ju

je

ji

Ja

Je

Ji

Je

Ju

La mujer , un garaje , la jarra ,

rojo , la reja , el jefe , la jaula ,

un pájaro , la naranja , el ojo

Juan tiene un ojo rojo.

El camión está en el garaje.

La ventana tiene una reja.

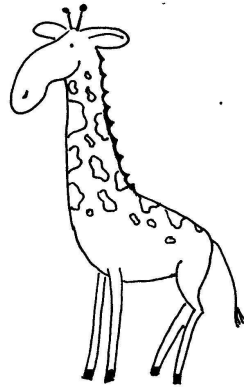
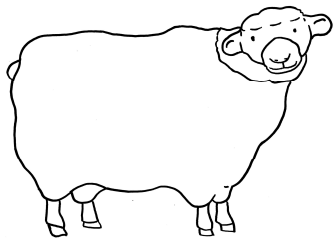

Una oveja y una jirafa

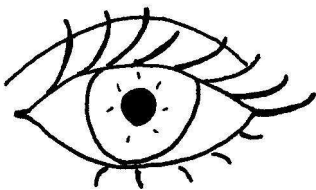

Ojo

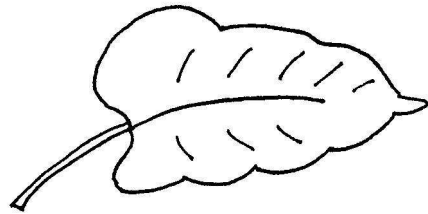

hoja

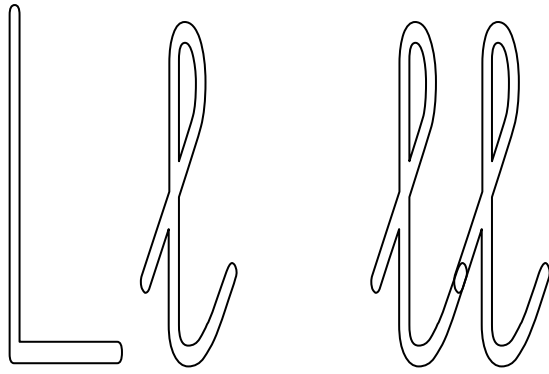

L la llo lli llu lle

Llave, lluvia, gallo

La gallina, una botella, la silla

Un billete, el pollito, un anillo

El anillo es de oro.

Siéntate en la silla.

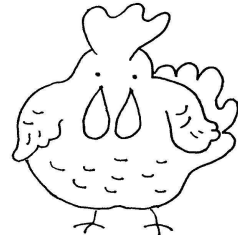

La gallina pone huevos.

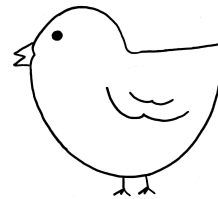
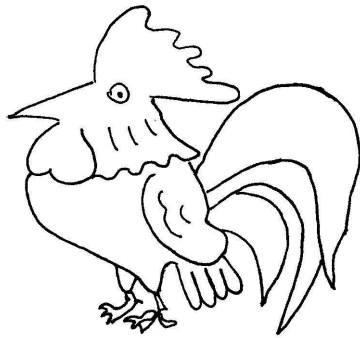

El gallo y el pollito



Han roto la botella de vino.

- Une y copia:

Calcetines



Hoja

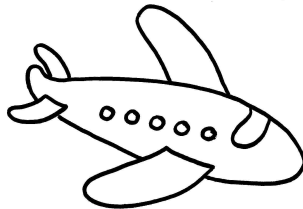

Gallo



avión



jirafa



manzana



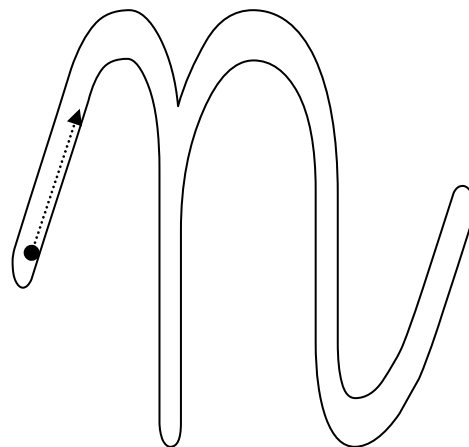
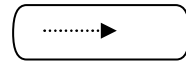
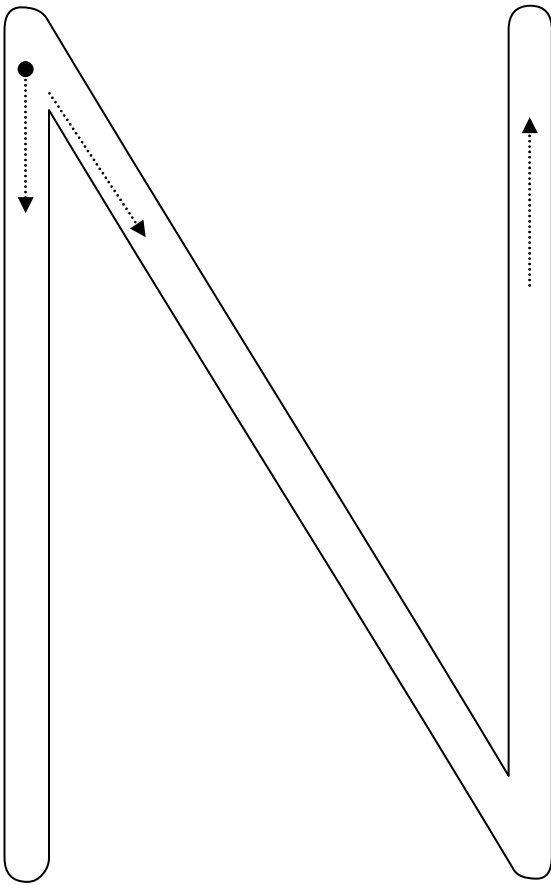
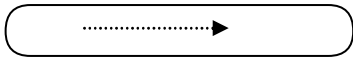

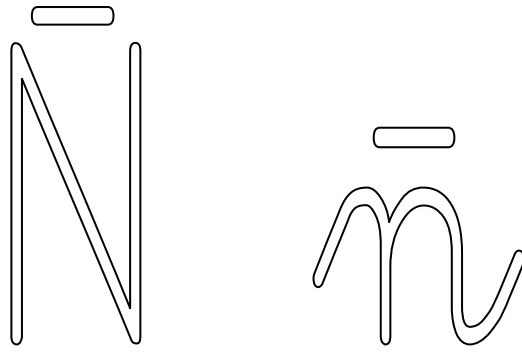

Ña ñu ñe ño ñi

niño, piña, araña, leña

Un año, la muñeca, el baño

Un puño, la montaña

La niña tiene sueño.

Pon más leña al fuego.

La piña está muy dulce.

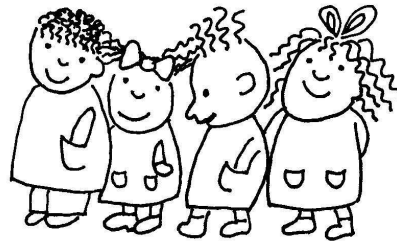

Los niños van a la escuela.

- Lee y dibuja:

araña

montaña

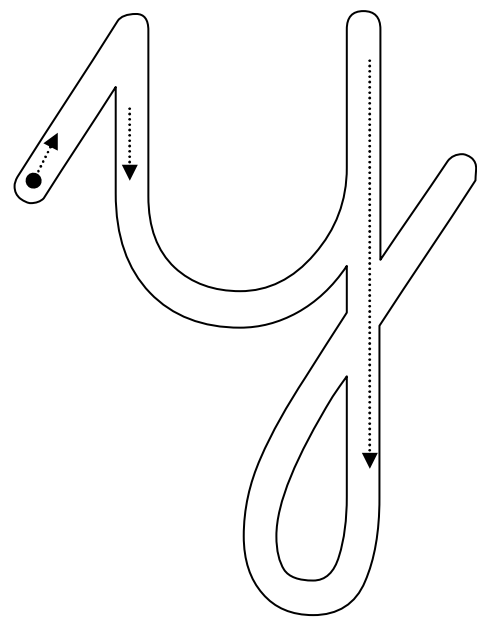
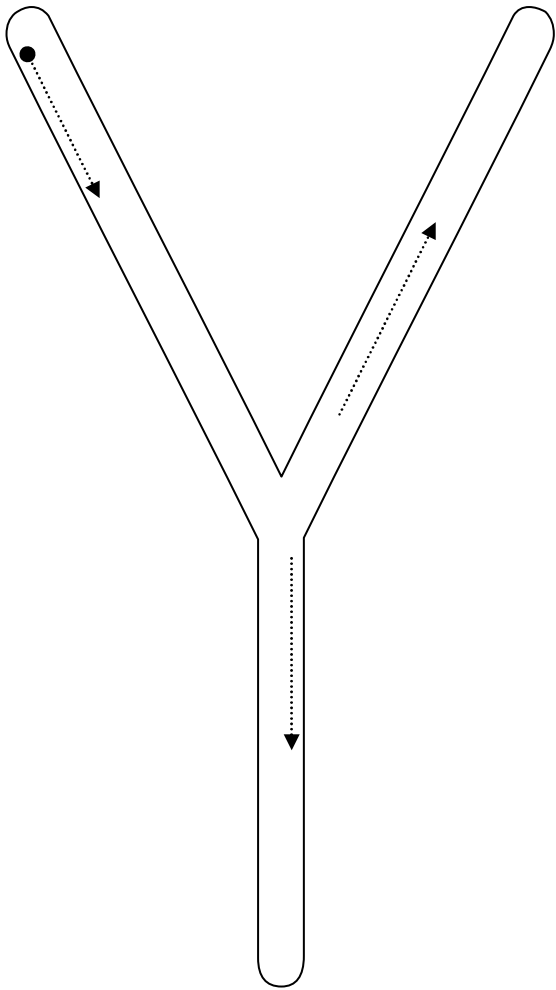

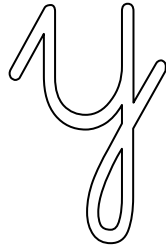
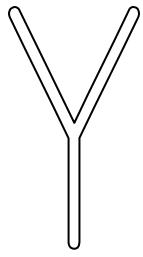

yo ye ya yi yu

Ya Yi Yu Ye

payaso, papaya, yema

rayo, mayo, raya

Comemos una papaya.

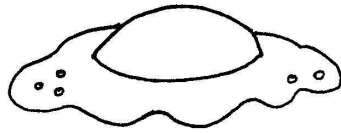

La yema del huevo es amarilla.

Dibuja una raya.

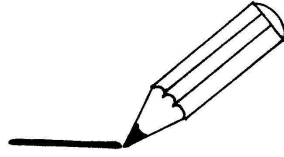

- Lee y dibuja:

rayo

papaya

Ch ch

Cho chi cha chu che

Chico , coche , chino , chocolate

ocho , leche , chorro , ducha

ficha , muchacho , cheque

De la manguera sale un chorro.

Me gusta el chocolate.

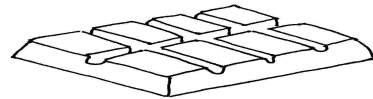

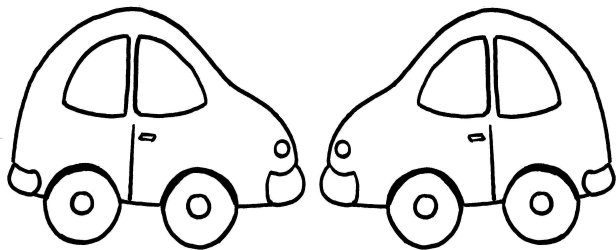

Dos coches se chocaron.

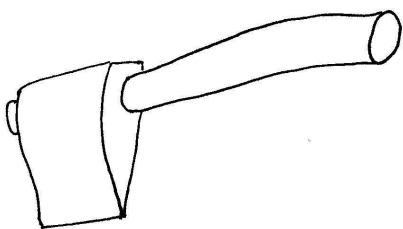

El hacha

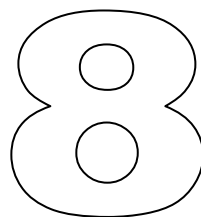

el ocho

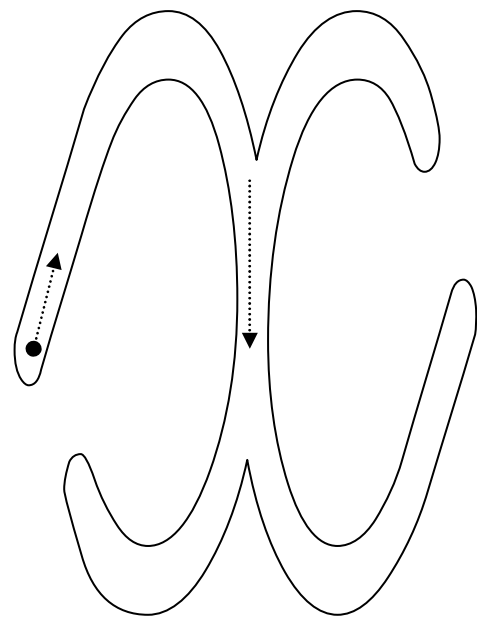
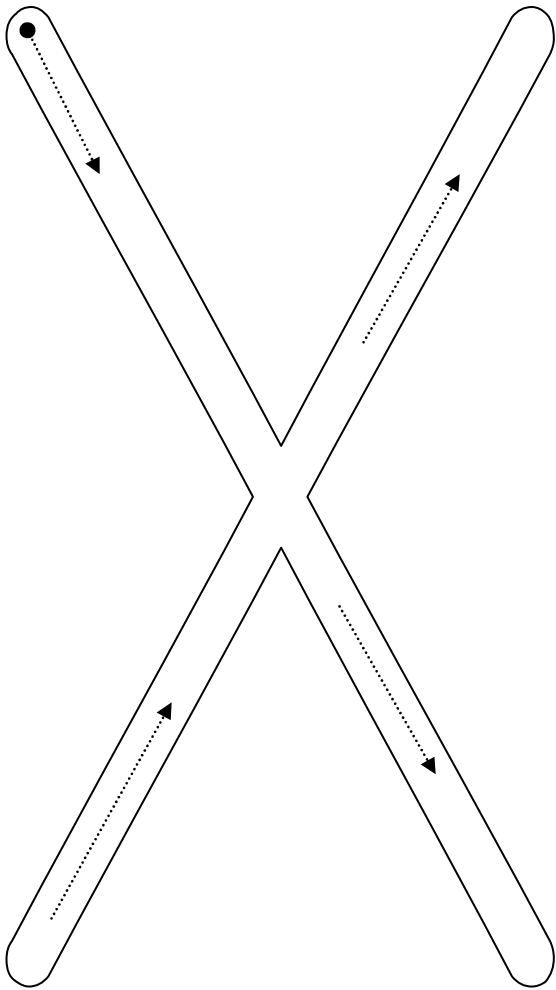

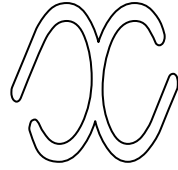
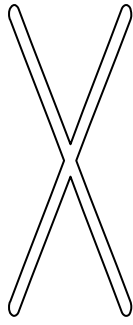

Xa xe xi xe xu

Máximo, boxeo, saxofón,

examen, taxi, sexto,

Félix conduce una excavadora.

María va a sexto curso.

Máximo es taxista.

Tiene éxito tocando el saxofón.

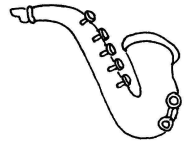

- Repasa y une:



8

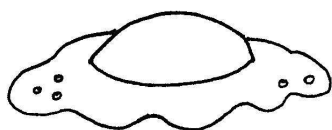

yema

hacha

mitos

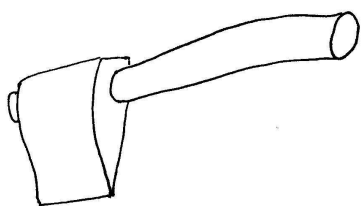

eche

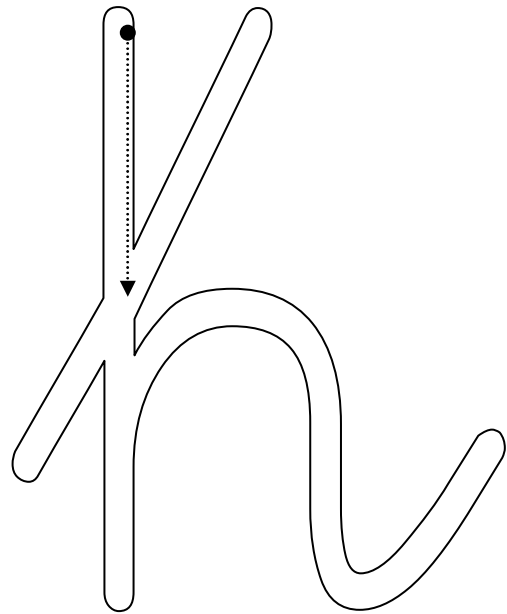
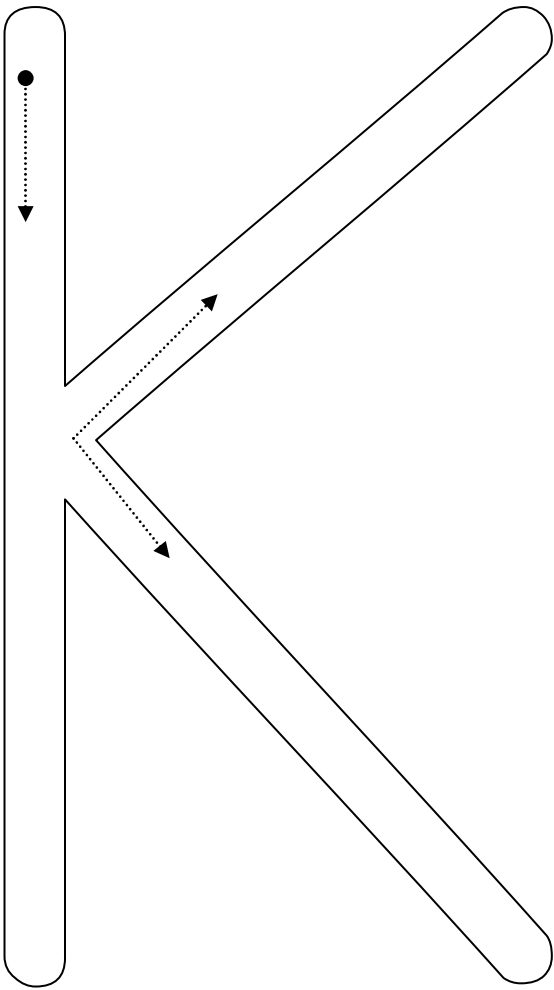

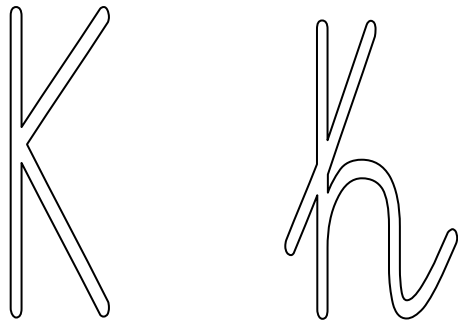

Ko ka ke ki ku

Un kilo , el karate , Kenia ,

Kiko tiene un koala.

Bicho es una isla.

Vende un kilo de tomates.



Esta niña se llama Kenia ,

es campeona de karate.

DICTADO

que - qui

cigüeña , pingüino , vergüenza

antigüedad, unguento ,

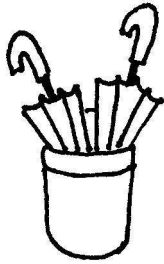

Paraguero

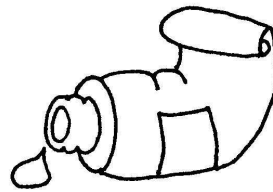

ungüento

Coloca el paraguas en el paraguero.

Dale unguento en la herida.

-Escribe el nombre:

